

Miles
Nelson[®]
Commercial



Commercial
Hardware Range
2021/2022



PROUDLY
NZ OWNED
& OPERATED

milesnelson.co.nz

**Miles
Nelson®**



**PROUDLY
NZ OWNED
& OPERATED**

Founded in 1928, Miles Nelson® is one of New Zealand's most trusted hardware companies and is proud to be 100% privately New Zealand owned and operated.

Based in Auckland, Miles Nelson® distributes nationwide and internationally, and is well known for its quality product range, innovative design and commitment to customer service.

Miles Nelson's long history as a manufacturer, coupled with in house technical expertise and custom designed proprietary products means that our range is specifically designed and manufactured to suit the New Zealand market.

The use of quality materials coupled with a range of high quality finishes and a suite of styles makes the Miles Nelson® range the ideal choice for commercial and residential projects.



Contents

Miles Nelson® offers a comprehensive range of commercial architectural hardware products:

04 Introducing MNC5000 series Mortice Locks	06 MNC Mortice Locks and Accessories	10 MNC Door Furniture	13 MNC Door Closers	14 MNC Lock and Furniture Kits
18 MNC Lock Specification by function	32 Other Miles Nelson products	45 Miles Nelson Warranties and Finishes Guide		

How to use this brochure

- The colour coded contents on this page will direct you with the book divided into a MNC product guide followed by a MNC specification section, then other MNC hardware.
- The 'Lock Specification by function' section starts with a quick reference guide to the different lock functions. Please note that the codes in this section refer to a locks function and should **not** be used for ordering product. The next pages in the specifying section give more detailed information on lock function. The specifying section finishes with a cam and snib matrix. Pages 6-16 onwards contain all product information and product ordering codes.
- Product finishes are designated by icons with a guide on page 46.

Miles Nelson® Service Guarantee

- Our people are great from our account representation to our customer service team and support staff. We make sure that we are easy to deal with and always go the extra mile to help.
- We have a technical support dedicated hotline to deal with any enquiries on a technical level (**see back cover** for contact details).
- Difot, our 'delivery in full, on time' rate is among the highest in country, so we always aim to have sufficient stock on hand.
- NZ owned and operated with a rich history dating back 90 years, Miles Nelson® always listens to the customer, and values their feedback as we continually aim to improve our product offering.

The MNC5000 Series Mortice Locks by Miles Nelson®

The 5000 series locks have been engineered for strength, precision, and durability using the highest quality components inside a high purity zinc alloy pressure cast lock body. Your confidence will be reassured knowing that the MNC5000 has been tested beyond 250,000 cycles, and successfully passed the fire endurance tests as specified on the following page. It is also backed up with a 25 year warranty.



Testing Information

Fire Rating

The MNC5000 Mortice lock has been successfully tested for endurance within fire door assemblies for up to 120 minutes on E-Core doorsets and 60 minutes on Pyropanel doorsets. Testing was conducted in accordance with Australian Standards AS1530.4-2014. The MNC5000 lockset did not initiate failure for the duration of the tests. A fire resistance assessment report has also been issued for the MNC5000 Mortice lock for usage on timber fire doors. The report states that the MNC5000 is suitable for use on 30 and 60 minute timber fire doors.



Please refer to the fire symbol throughout this catalogue for fire door application door hardware.

For more information on fire ratings, please contact your Miles Nelson® representative or check door manufacturers approved lists.

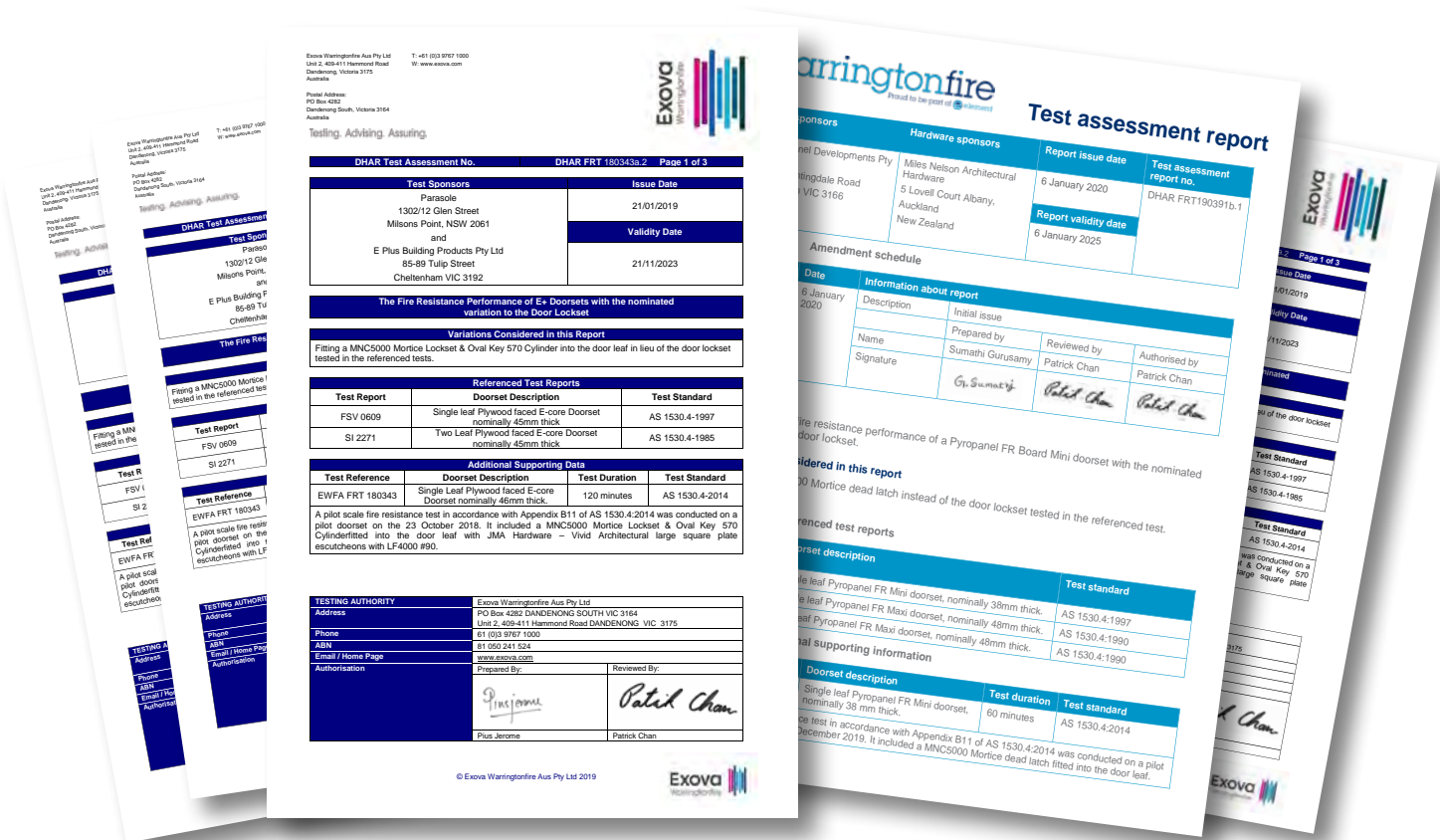

MNC5000 Series Wide Style Mortice Locks

25 YEAR
MILES NELSON
WARRANTY



MNC5000

SS

60mm Backset Mortice Lock

- 88mm case depth
- 8mm spindle hub, Spindle supplied
- Suits up to 55mm thick door
- See page 22 for overall dimensions
- 41mm centre to centre rose fixings
- 51mm centre to centre diagonal fixings
- Lever retracts latch at 33°



MNC5000ND

SS

60mm Backset Mortice Lock (No Hub Disc)

- Use with through spindle handle escutcheons
- 8mm open spindle hub
- Lever retracts latch at 33°
- No locking bar



MNC5409

SS

60mm Backset Mortice Passage Latch

- 8mm spindle hub
- Lever retracts latch at 33°
- Non locking / no deadlatch



MNC5100

SS

60mm Backset Mortice Deadbolt

- Zinc diecast body / stainless bolt
- See page 23 for dimensions



MNC5300

SS

60mm Backset Mortice Sliding Door Deadbolt

- Zinc diecast body / stainless bolt
- See page 26 for dimensions



MNC5000RK

SS

Latchbolt Rebate Kit

- For 5000, 5409 and 5000ND
- See page 29 for dimensions

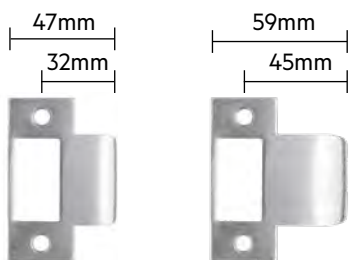

MNC5000-02 (Standard)
MNC5000-03 (Extended)

SS

Strike Plate

- For 5000 and 2200
- See page 29 for dimensions



MNC5100-02

SS

Deadbolt/Sliding Lock Strike

- For 5100 and 5300
- See page 29 for dimensions



MNC5100RK

SS

Deadbolt Rebate Kit

- For 5100
- See page 29 for dimensions

MNC2000 Series Narrow Style Mortice Locks

10 YEAR
MILES NELSON
WARRANTY



MNC2200

SS

23mm Backset Mortice Deadlatch

- 8mm spindle hub
- Lever retracts latch at 45°
- Comes with long faceplate
- Includes turnadaptor
- See page 24 for dimensions



MNC2200EP

SS

28mm Backset Special Mortice Latch

- Adjustable 28-29mm backset
- Short case depth 39mm
- 8mm through spindle
- Lever retracts latch at 33°
- Suits card access handle escutcheons
- Non-locking lock body
- Comes with long faceplate



MNC2200/SFP

(Short Face Plate)

SC

MNC2200/LFP

(Long Face Plate)

SS

Face Plates

- For 2200 range
- Short face plate 155mmH x 25mmW
- Long face plate 254mmH x 25mmW

MNC2200E

SS

28mm Backset Mortice Deadlatch

- Lever retracts latch at 33°
- 8mm spindle hub
- Comes with long faceplate
- Includes turnadaptor
- See page 22 for dimensions

MNC2100L (Long throw)

MNC2100S (Short throw)

SS

Mortice Deadbolt

- Long throw 34mm bolt projection
- Short throw 21mm bolt projection
- 22mm backset
- Includes short and long faceplates, escutcheons and strike
- Includes 2 x cams but order key cylinders (MNC570RE) and turns (MNC590CT) separately (see page 9)
- See page 23 for dimensions



MNC2300

SS

Mortice Hook Bolt

- 28mm bolt projection with 21mm hook reach
- 22mm backset
- Includes short and long faceplates, escutcheons and strike
- Includes 2 x cams but order key cylinders (MNC570RE) and turns (MNC590CT) separately (see page 9)
- See page 26 for dimensions



MNC Mortice Lock Accessories

Kick Off (KO) Adaptors (Anti-lockout)

Kick off (KO) function adds a feature to the lock that makes it unable to be locked when the door is in the opened position. See page 18 for handing guide. See pages 30-31 for cam and adaptor matrix.



MNCCK2CAM



MNCAD5200-02RH

- For right hand door (See page 18)



MNCAD5200-02LH

- For left hand door (See page 18)

Turn Snib Adaptors

Refer to pages 30 and 31, cam and snib matrix for door function.



MNCAD5000-01LH

Nightlatch and Special Classroom Adaptor

- For right hand door (See page 18)
- For night latch and special classroom functions
- Use with cam to unlock door and also retract latch
- For full explanation see 5208PWD on page 25
- W2CAM must be fitted upside down when turnsnib is used



MNCAD5000-01RH

Nightlatch and Special Classroom Adaptor

- For left hand door (See page 18)
- For night latch and special classroom functions
- Use with cam to unlock door and also retract latch
- For full explanation see 5208PWD on page 25
- W2CAM must be fitted upside down when turnsnib is used



MNCAD5200-01

Common Butterfly Adaptor

- Common turn adaptor
- Use with 5000 and 2200, 2200E locks



MNCAD5100-01

Deadlock Sliding Lock Adaptor

- Use with 5100 and 5300 locks

Oval Cylinder Cams

Refer to pages 30 and 31, Cam and Snib Matrix for door function.



MNCW2CAM

- Use with turnsnib



MNCX2CAM

- Use for latch retraction only



MNCY2CAM

- Use with 5100 and 5300 deadbolts



MNCZ2CAM

- Use to lock and unlock handles with oval key or turn cylinder



MNCXZCAM

- Supplied as pair for courtroom function (page 28)



MNCRECAM

- Use with 2100 and 2300 deadbolts

Oval Cylinders



MNC570

MNC570KA1 (Keyed alike)

MNC570KA5 (Keyed alike)

MNC570KA10 (Keyed alike)



C4 Oval Key Cylinder

- Cylinder is 34mm overall
- Includes 2 keys / Key alike includes 1 key
- Compatible with security profile plugs
- Supplied with MNCZ2CAM
- Suits up to 53mm thick door



MNC570E

MNC570EKA (Keyed alike)



C4 Extended Oval Key Cylinder

- Cylinder is 41mm overall
- Includes 2 keys (C4 profile)
- Compatible with security profile plugs
- Supplied with MNCZ2CAM
- Suits 55-60mm thick door



MNC570SB

MNC570SBKA1 (Keyed alike)

C4 Oval Key Cylinder

- Satin Brass finish
- Cylinder is 34mm overall
- Great for construction cylinders
- Includes 2 keys / keyed alike includes 1 key
 - Supplied with MNCZ2CAM / Keyed alike - MNCX2CAM
- Suits up to 53mm thick door



MNC570HBLH (Left hand)

MNC570HBRH (Right hand)

C4 Oval Hold Back

- Includes 2 keys (C4 profile) and cam
- Available in left or right hand (see page 18)
- Allows the latchbolt to be held in the opened position and the key removed



MNC590CT

Oval Thumb-Turn



- Comes with MNCRECAM for use with 2100 and 2300 locks



MNC590CLT

Large Oval Thumb-Turn



- Special cam, only for use with 2100 and 2300 locks
- Grub screw to change handing
- Reversible handing



MNC590E

Oval Cylinder Escutcheon Pair



- Use with 2100 and 2300 locks



MNCKBC45PIN

MNCKBC46PIN

Key Blank

- Chrome plate brass key blanks
- 5 and 6 pin C4 profile

Oval Cylinder Ordering Guide

MNC570	supplied with Z2 cam
MNC570W2	use with turn snib
MNC570X2	use for latch retraction only
MNC570Y2	use with 5100 and 5300 bolt locks
MNC570RE	use with 2100 and 2300 bolt locks

Add 'KA' to end of product code for keyed alike. Refer to cam matrix on pages 30-31.

MNC Door Furniture

Wide Long Plate (Satin Chrome on Brass)

Quick Handing Change Design

Door Handle Specifications:

Base

Length: 175mm

Width: 48mm

Depth: 11.5mm

Screwfix CTC: 158mm

Screw: M4

Spindle: 7.6mm

Material: Brass

Warranty: 10 years

10 YEAR
MILES NELSON
WARRANTY



MNC154CLTLH/90 (Left hand)

MNC154CLTRH/90 (Right hand)

Note: Image shown is left hand

Internal with lever and large turn



MNC151/90 SC

External with Lever and Cylinder Hole



MNC155/90 SC

External with Lever – no Cylinder Hole



MNC101 SC

External with Cylinder Hole – no Lever



MNC105 SC

External – no Lever or Cylinder Hole



MNC153/90 SC

External with Lever and Indicator and Release



MNC152/90 SC

Internal with Lever and Cylinder Hole



MNC156/90 SC

Internal with Lever – no Cylinder Hole



MNC154/90 SC

Internal with Lever and Turn

Narrow Style (Satin Chrome on brass)

Door Handle Specifications:

Base

Length: 185mm

Width: 26mm

Depth: 12.5mm

Screwfix CTC: 159mm

Spindle: 7.6mm

Screw: M4

Material: Brass

Warranty: 10 years

10 YEAR
MILES NELSON
WARRANTY



MNC151N/90 (SC)

External with Lever
and Cylinder Hole



MNC155N/90 (SC)

External with Lever –
no Cylinder Hole



MNC101N (SC)

External no Lever
and Cylinder Hole



MNC105N (SC)

External no Lever –
no Cylinder Hole



MNC152N/90 (SC)

Internal with Lever
and Cylinder Hole



MNC156N/90 (SC)

Internal with Lever –
no Cylinder Hole



MNC154N/90 (SC)

Internal with Lever
and Turn



MNC150SCREW

Extended Screw

- 80mm M4 SS screw (pair)
- Suits up to 65mm door
- Use with wide and narrow long plate furniture

MNC Door Furniture

Round Rose and Accessories

10 YEAR MILES NELSON WARRANTY

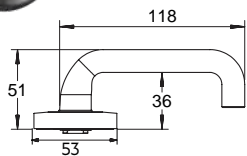

MNCR53/90

SC

53mm Round Rose Lever Pair

- Satin Chrome on brass lever
- Screw on cover
- Screw fixing centre to centre 41mm
- Takes 7.6mm spindle



MNCR53SCREW

Extended Screw

- 80mm M4SS (pair)
- Suits up to 65mm door
- Use with R53 Rose Levers and accessories
- Break off sections



MNCR53B

SC

Round Rose Blank

- Fixings included for back to back and face fixing
- For back to back fixing use with MNCR53CE
- Screw on cover



MNCR53TS

SC

Turn Snib

- Fixings included for back to back and face fixing
- For back to back fixing use with MNCR53CE / MNCR53ER / MNCR53ERIND
- Screw on cover



MNCR53TSDA

SC

Large Turn Snib

- Fixings included for back to back and face fixing
- For back to back fixing use with MNCR53CE / MNCR53ER / MNCR53ERIND
- Screw on cover



MNCR53ERIND

SC

Emergency Release (Indicating)

- Fixings included for back to back and face fixing
- For back to back fixing use with MNCR53TS or MNCR53TSDA
- Screw on cover



MNCR53ER

SC

Emergency Release (Non-Indicating)

- Fixings included for back to back and face fixing
- For back to back fixing use with MNCR53TS or MNCR53TSDA
- Screw on cover



MNCR53CE

SC

Oval Cylinder Escutcheon

- Fixings included for back to back and face fixing
- For back to back fixing use with MNCR53B or MNCR53TS or MNCR53TSDA
- Screw on cover



MNCSPINDLE

Spindle

- Stepped 7.6mm to 8mm spindle
- Suits all MNC locks and furniture on doors up to 60mm thick
- Supplied as a pair with springs
- Included with MNC5000 and MNC2200 locks



MNCR53TL

Tubular Latch

- 7.6mm spindle
- Includes Strike



MNCR53TB

Tubular Bolt

- Takes a 6mm x 2mm flat spindle
- Includes Strike

MNC Door Closers

The hydraulic 8000 series door closers are an aluminium body with a silver finish and have a 10 year warranty. Products on this page with the fire icon have been tested on a range of timber and mineral core approved fire doors. Contact Miles Nelson for more information or check door manufacturers approved lists.

10 YEAR MILES NELSON WARRANTY



MNC8404BC/DA

SC

EN3 – 4 Closer

- Adjustable back check/delay action function
- Includes parallel fixing bracket
- Adjustable closing and latching speeds
- Spare magnetic trim cover (MNC8404CP)



MNC8626BC/DA

SC

EN2 – 6 Closer (adjustable)

- Adjustable back check/delay action function
- Includes parallel fixing bracket
- Adjustable closing and latching speeds
- Spare magnetic trim cover (MNC8626CP)



MNC D002

SS

Door Selector

- For double doors
- Allow self latching doors to close in correct sequence
- Fixings included
- 300mm length



MNC8000DP

SC

Drop Plate

- Suits 8404 and 8626
- Fixings included



**MNC8404HO
MNC8626HO**

SC

Hold Open Arm

- MNC8404HO suits MNC8404BC/DA
- MNC8626HO suits MNC8626BC/DA
- Ball joint for positive hold open



**MNC8404SA
MNC8626SA**



SC

Slide Arm Kit

- MNC8404SA suits MNC8404BC/DA
- MNC8626SA suits MNC8626BC/DA
- Removable hold open feature
- Use of slide arm reduces closer power by 30%
- Fixings included



MNC8000ZB

SC

Z Bracket

- Suits 8404 and 8626
- Fixings included
- For flush mount parallel fixing



MNC8000PAP

Parallel Bracket Packer

- For use on aluminium joinery
- 10mm thick

Model	Dimension (mm)			Hole Spacing (mm)		Applicable door weight (kg)	Applicable door width (mm)	Power Size
	A	B	C	D	E			
MNC8404BC/DA	207	55	40	50	39	Up to 85	Up to 1100	3-4
MNC8626BC/DA	236	61	43	50	45	Up to 150	Up to 1400	2-6 Adjustable

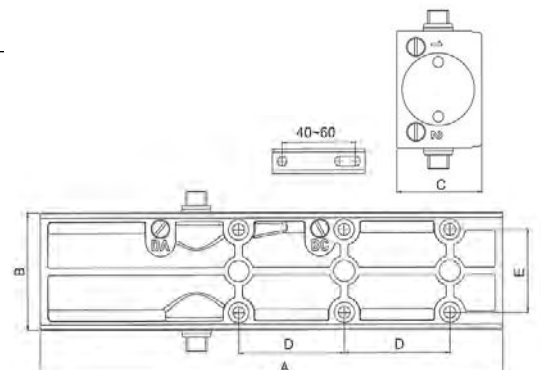

MNC Door Hardware Trade Kits

- All kits are supplied with a fire rated mortice lock and forged brass door handles suitable for commercial and residential applications
- 25 year mechanical warranty on commercial mortice lock / 10 year warranty on handles
- Includes installation template and setup instructions
- Suitable for retro fitting and new installations



**FIRE
RATED**



**25
YEAR
MECHANICAL
WARRANTY**



Trade Box Kits

Kit products are sent in a non-sealed single outer box, designed to help door by door supply.

Product Code	Description	Components	Products
MNCKITWL90CL/ST (Without cylinder) MNCKITWL90CL/ST - CYL (With cylinder)	Classroom / Storeroom Kit (non-handed)	Mortice Lock: MNC5000 Lever: MNC151/90 Lever: MNC156/90 Cylinder: MNC570 optional	
MNCKITWL90OF (Without cylinder) MNCKITWL90OF - CYL (With cylinder)	Office Kit (non-handed)	Mortice Lock: MNC5000 Lever: MNC151/90 Lever: MNC154/90 Snib Adaptor: MNCAD5200-01 Cylinder: MNC570 optional	
MNCKITWL90PS	Passage Kit (non-handed)	Mortice Lock: MNC5409 Lever: MNC155/90 Lever: MNC156/90	

Product Code	Description	Components	Products
MNCKITWL90PR	Privacy Kit (non-handed)	Mortice Lock: MNC5000 Lever: MNC1531/90 Lever: MNC154/90 Snib Adaptor: MNCAD5200-01	
MNCKITWL90PRDAR	RH Privacy Disabled Access Kit	Mortice Lock: MNC5000 Lever: MNC1531/90 Lever: MNC154CLTRH/90 Snib Adaptor: MNCAD5200-01	
MNCKITWL90PRDAL	LH Privacy Disabled Access Kit	Mortice Lock: MNC5000 Lever: MNC1531/90 Lever: MNC154CLTLH/90 Snib Adaptor: MNCAD5200-01	
MNCKITWR90CL/ST (Without cylinder) MNCKITWR90CL/ST - CYL (With cylinder)	Classroom / Storeroom Rose Kit	Mortice Lock: MNC5000 Handle: MNCR53/90 Lever: MNCR53CE Cylinder: MNC570 optional	
MNCKITWR90OF (Without cylinder) MNCKITWR90OF - CYL (With cylinder)	Rose Office Kit	Mortice Lock: MNC5000 Handle: MNCR53/90 Lever: MNCR53CE Lever: MNCR53TS Snib Adaptor: MNCAD5200-01 Cylinder: MNC570 optional	
MNCKITWR90PS	Rose Passage Kit	Mortice Lock: MNC5409 Handle: MNCR53/90	
MNCKITWR90PR	Rose Privacy Kit	Mortice Lock: MNC5000 Handle: MNCR53/90 Lever: MNCR53ERIND Lever: MNCR53TS Snib Adaptor: MNCAD5200-01	
MNCKITWR90PRDA	Rose Privacy Disabled Access Kit	Mortice Lock: MNC5000 Handle: MNCR53/90 Lever: MNCR53ERIND Lever: MNCR53TS Snib Adaptor: MNCAD5200-01	

MNC Door Hardware Retail Kits

- All kits are supplied with a fire rated mortice lock and forged brass door handles suitable for commercial and residential applications
- 25 year mechanical warranty on commercial mortice lock / 10 year warranty on handles
- Includes installation template and setup instructions
- Suitable for retro fitting and new installations
- Tamper proof seals on box suitable for retail



Retail Box Kit



Product Code	Description	Components	Products
MNCKITEL	Entrance Lock Kit (Non-handed)	Mortice Lock: MNC5000 Lever: MNC151/90 Lever: MNC154/90 Snib Adaptor: MNCAD5200-01 Key Barrel: MNC570 incl keys	
MNCKITST	Storeroom Lock Kit (Non-handed)	Mortice Lock: MNC5000 Lever: MNC151/90 Lever: MNC156/90 Key Barrel: MNC570 incl keys Cams: MNCX2CAM/MNCZ2CAM for storeroom & classroom functions	
MNCKITPS	Passage Set Kit (Non-handed)	Mortice Lock: MNC5409 Lever: MNC155/90 Lever: MNC156/90	
MNCKITPR LH	Privacy Lock Kit (Left Hand)	Mortice Lock: MNC5000 Lever: MNC1531/90 Lever: MNC154CLTLH/90 Snib Adaptor: MNCAD5200-01	
MNCKITPRRH	Privacy Lock Kit (Right Hand)	Mortice Lock: MNC5000 Lever: MNC1531/90 Lever: MNC154CLTRH/90 Snib Adaptor: MNCAD5200-01	



MNC Lock Specification by Function

How to Specify (Quick reference chart pages 20-21)

- Nominate the correct backset as required** – (e.g. 5 = 60mm Backset)
- Select the correct lock function** – (e.g. 2 = Vestibule)
- Select sub function** – Select the correct locking requirements (e.g. 00 = Cylinder & Turnsnib)
- Specify handing of lock** – This is to determine the hand of the lock (e.g. RH = Right Hand)
- Specify finish** – (e.g. SC = Satin Chrome)
- Options** – To select additional options such as: H = Hold Back, K = Kick Off

Door Handing

In New Zealand doors are handed in accordance with British practice and the direction of opening is always viewed from the OUTSIDE. The closing face of the door is the one closing against the stop bead. Which side of the door is the outside?

- the outside of an exterior door is the street side or entry side
- the outside of a room door is the corridor side
- the outside of a cupboard or closet door is the room, corridor or hall side
- the outside of a single communicating door is the side from which the butt hinge are invisible when the door is closed.
- the outside of double communicating door is the space between the two doors.

A Right Hand Sliding Door is one which closes to the right and has the lock on the right hand edge, viewed always from the outside. Patio or Privacy locks are used on either patio or toilet doors. Operation to lock or unlock handles are either turnsnibs or outside emergency release.

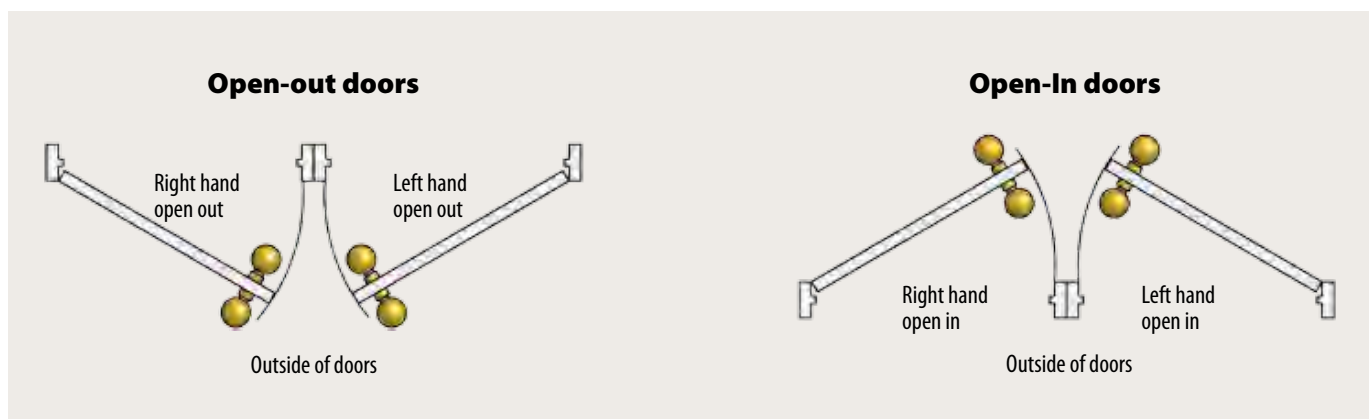

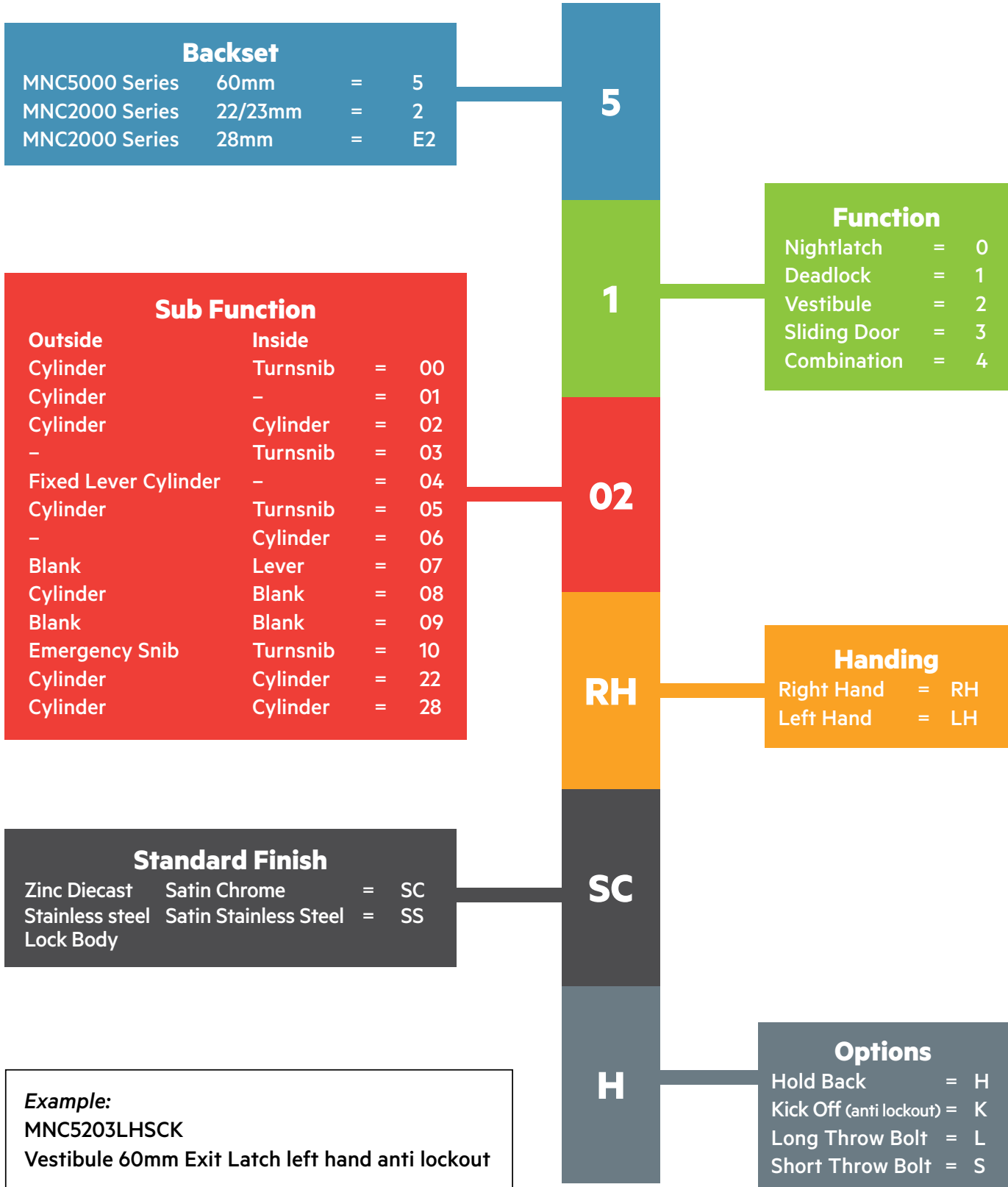

Quick Reference Chart

Nightlatches

For further details see pages 22

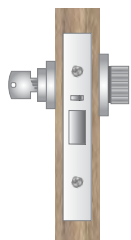

**5000
2000
E2000**



**5001
2001
E2001**

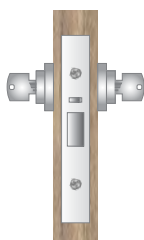

**5002
2002
E2002**



**5003
2003
E2003**

Deadlocks

For further details see pages 23

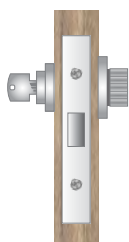

**5100
2100L
2100S**



**5101
2101L
2101S**

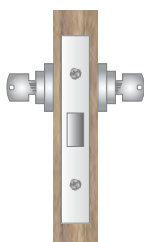

**5102
2102L
2102S**



**5103
2103L
2103S**

Vestibule Locks

For further details see pages 24-25

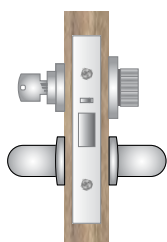

**5200
2200
E2200**

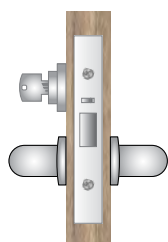

**5201
2201
E2201**

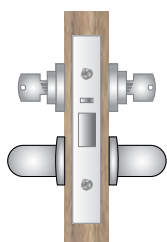

**5202
2202
E2202**

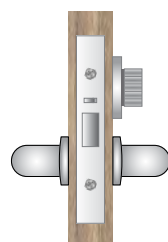

**5203
2203
E2203**

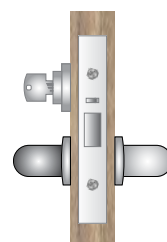

**5204
2204
E2204**

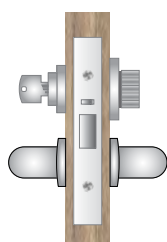

**5205
2205
E2205**

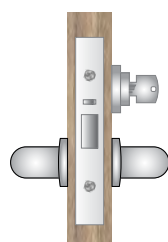

**5206
2206
E2206**

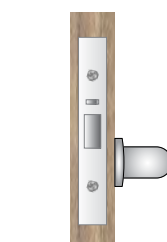

**5207
2207
E2207**

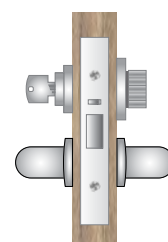

**5208PWD
2208PWD
E2208PWD**

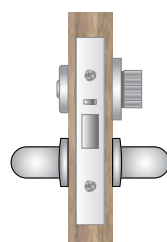

**5210
2210
E2210**

Sliding Doors

For further details see pages 26

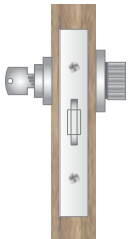

5300
2300

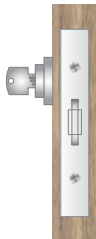

5301
2301

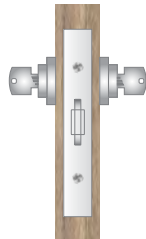

5302
2302

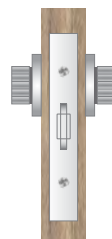

5303
2303

Combination

For further details see pages 27-28

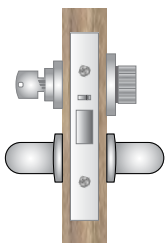

5400
2400
E2400

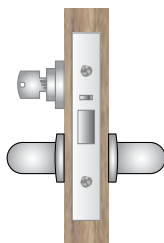

5401
2401
E2401

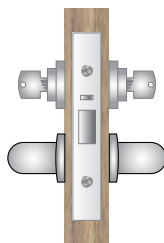

5402
2402
E2402

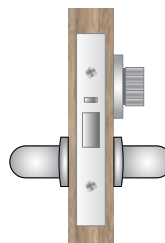

5403
2403
E2403

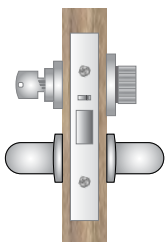

5405
2405
E2405

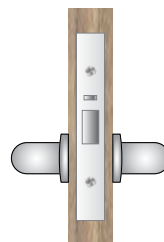

5409
2409
E2409

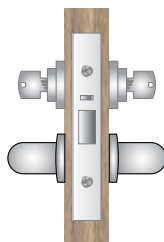

5422
2422
E2422

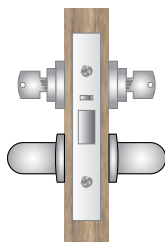

5428
2428
E2428

5000/2000 Series Mortice Nightlatches

Deadlocking mortice nightlatches feature a latchbolt that is retracted by a series of cylinder or turnsnib configurations. The latchbolt is automatically locked when the door is closed.



MNC5000

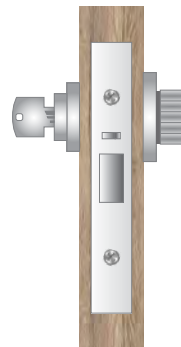
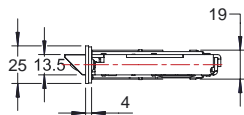
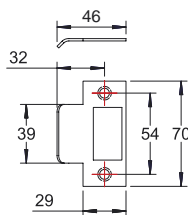
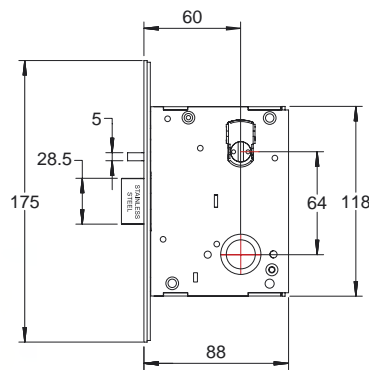

Nightlatch
5000 / 2000 / E2000

Cylinder & Turnsnib

Opened by key from outside.
Opened by turnsnib from inside.
Latchbolt automatically deadlatches when door is closed. Available in left and right handing.



Cylinder Nightlatch
5001 / 2001 / E2001

Single Cylinder

Opened by key from outside.
Latchbolt automatically deadlatches when door is closed. Available in left and right handing.

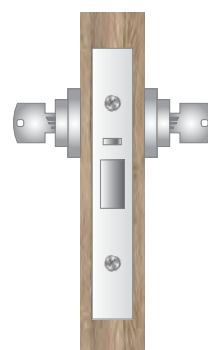

Communicating Door Lock
5002 / 2002 / E2002

Double Cylinder

Opened by key from either side.
Latchbolt automatically deadlatches when door is closed. Available in left and right handing.



Exit Door Latch
5003 / 2003 / E2003

Turnsnib

Opened by turnsnib from inside.
Latchbolt automatically deadlatches when door is closed. Available in left and right handing.



MNC2200



MNC2200E

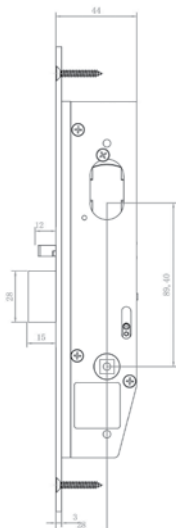

5100/2100 Series Mortice Deadlocks

Deadbolts have a rectangular bolt. Deadbolts are operated by either cylinders or turnsnibs to retract the latchbolt.



MNC5100

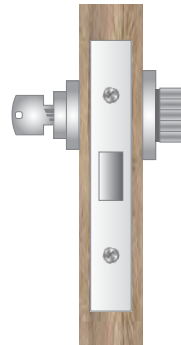
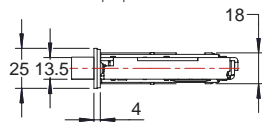
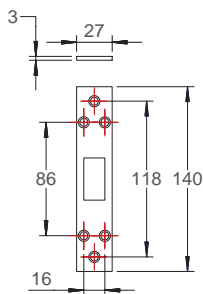
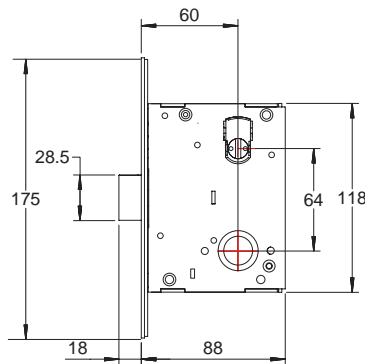

**Deadlock
5100 / 2100**

Cylinder & Turnsnib

Opened by key from outside.
Opened by turnsnib from inside.
Available in left and right handing.

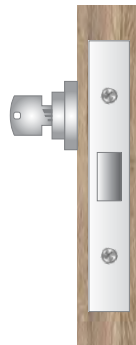

**Lockup Shop Deadlock
5101 / 2101**

Single Cylinder

Opened by key from outside.
Available in left and right handing.

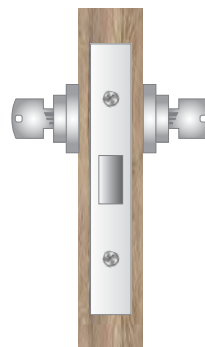

**Glass Door Deadbolt
5102 / 2102**

Double Cylinder

Opened by key from either side.
Available in left and right handing.



MNC2100L (Long throw)

MNC2100S (Short throw)

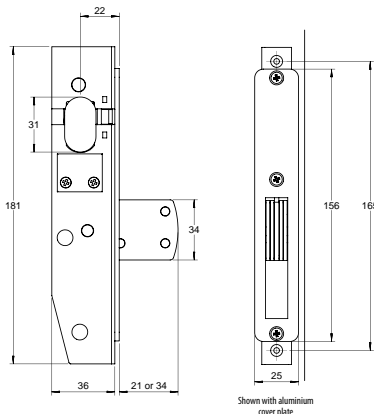

**Exit Deadbolt
5103 / 2103**

Turnsnib

Opened by turnsnib from inside.
Available in left and right handing.

5200/2200 Series Mortice Vestibule Locks

The vestibule locks are fully reversible and the function can be changed without removing the case. The auxiliary deadlatch bolt automatically locks the main bolt on closing the door. The vestibule locks always feature an inside handle to allow egress in case of emergencies.



MNC5000

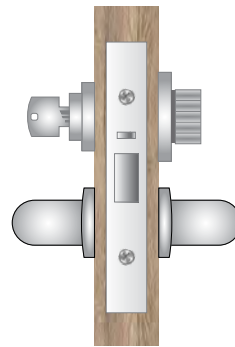
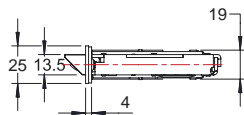
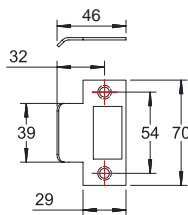
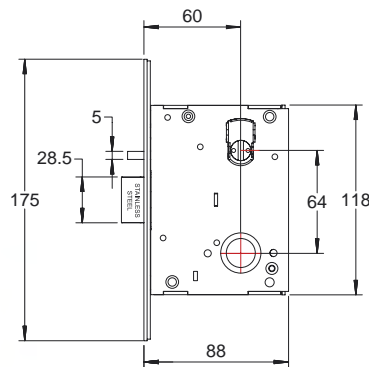

**Vestibule or Entrance Lock
5200 / 2200 / E2200**

Cylinder & Turnsnib

Latchbolt operated by handle from either side. Outside handle is locked or unlocked by inside turnsnib. Key outside retracts latchbolt only. Inside handles are always free. Latchbolt automatically deadlatches when door is closed. Available in left and right handing.

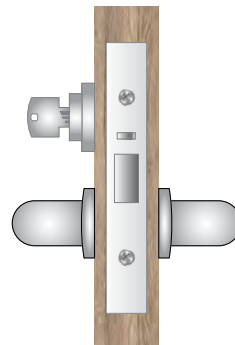

**Class Room Lock
5201 / 2201 / E2201**

Single Cylinder

Latchbolt operated by handle from either side. Outside handle is locked or unlocked by key from outside. Inside handles are always free. Latchbolt automatically deadlatches when door is closed. Available in left and right handing.

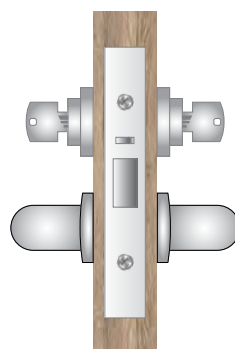

**Exterior or Exit Door Lock
5202 / 2202 / E2202**

Double Cylinder

Latchbolt operated by handle from either side. Outside handle is locked or unlocked by key from inside. Key outside retracts latchbolt only. Inside handles are always free. Latchbolt automatically deadlatches when door is closed. Available in left and right handing.

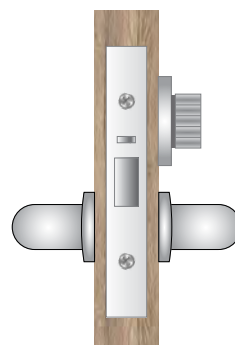

**Exit Door Latch
5203 / 2203 / E2203**

Turnsnib

Latchbolt operated by handle from either side. Outside handle is locked by turnsnib inside. Inside handles are always free. Latchbolt automatically deadlatches when door is closed. Available in left and right handing.



MNC2200



MNC2200E

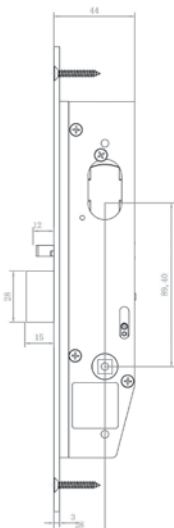

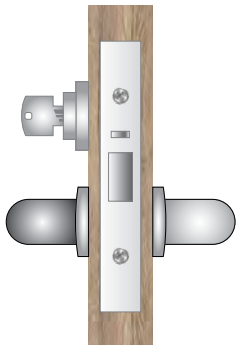

Storeroom Lock
5204 / 2204 / E2204

Single Cylinder

Key outside retracts latchbolt only. Outside handle is ridged at all times. Inside handles are always free. Latchbolt automatically deadlatches when door is closed. Available in left and right handing.



Exit Door Latch
5207 / 2207 / E2207

No cylinder or turnsnib

Latchbolt operated by handle from inside only. No outside handle. Latchbolt automatically deadlatches when door is closed. Available in left and right handing.

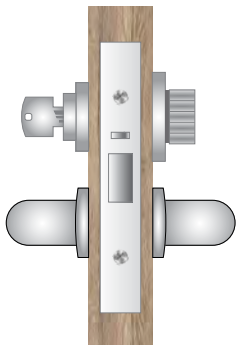

Office Lock
5205 / 2205 / E2205

Cylinder & Turnsnib

Latchbolt operated by handle from either side. Outside handle is locked or unlocked by either key from outside or turnsnib inside. Inside handles are always free. Latchbolt automatically deadlatches when door is closed. Available in left and right handing.

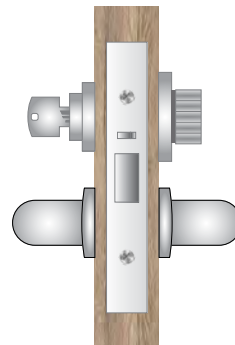

Special Classroom Lock
5208PWD / 2208PWD / E2208PWD

Cylinder & Turnsnib

Latchbolt operated by handles either side except when outside handle is made inoperable by the key from outside or turn snib inside. Cylinder has dual function. When turned towards strike, cylinder unlocks outside handle. If turned further, cylinder will also retract Latchbolt. Inside handles are always free. Available in left and right handing.

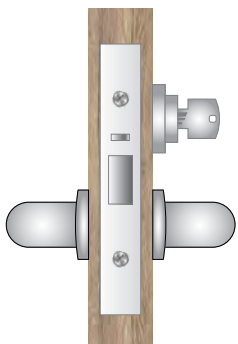

Exit Door Lock
5206 / 2206 / E2206

Single Cylinder

Latchbolt operated by handle from either side. Outside handle is locked or unlocked by inside cylinder. Latchbolt automatically deadlatches when door is closed. Available in left and right handing.

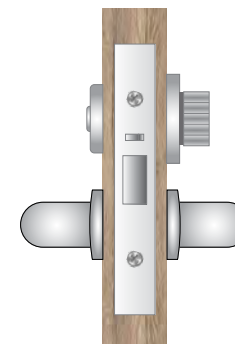

Privacy Lock
5210 / 2210 / E2210

Turnsnib & release

Latchbolt operated by handles either side. Outside handle is locked. Inside handles are always free. Has Kick Off function. Available in left and right handing.

5300/2300 Series Mortice Sliding Door Locks

Sliding door locks are operated by either cylinder or turnsnib configuration. The deadbolt has a claw bolt that engages behind the strike plate to prevent the bolt being withdrawn while sliding the door.



MNC5300

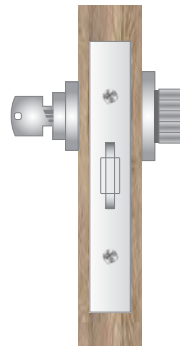
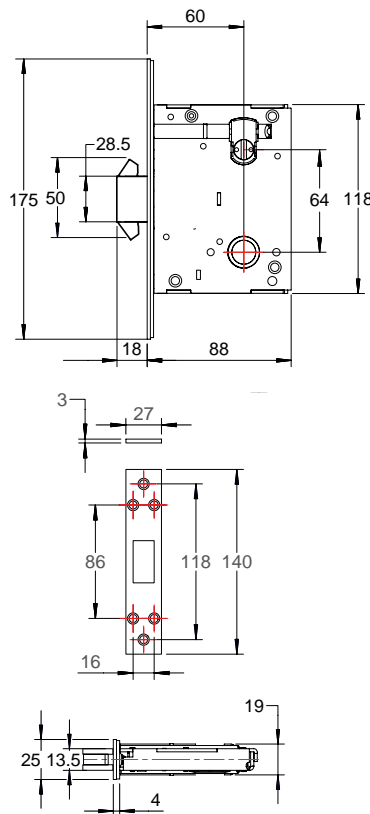

**Sliding Door Deadlock
5300 / 2300**

Cylinder & Turnsnib

Opened by key from outside.
Opened by turnsnib from inside.
Available in left and right handing.

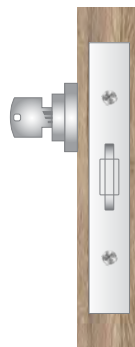

**Lock Up Shop Sliding
Deadlock
5301 / 2301**

Single Cylinder

Opened by key from outside.
Available in left and right handing.

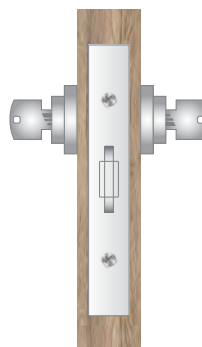

**Sliding Glass Door
Deadlock
5302 / 2302**

Double Cylinder

Opened by key from either side.
Available in left and right handing.



MNC2300

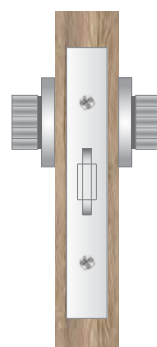
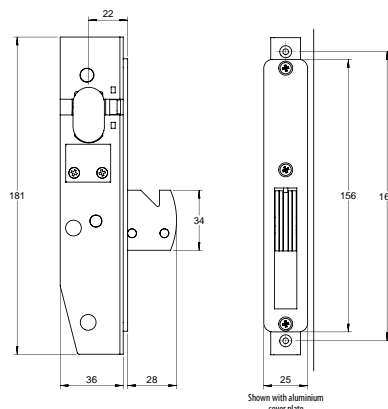

**Exit Sliding Door
Deadlock
5303 / 2302**

Turnsnib

Opened by turnsnib from inside.
Available in left and right handing.

5400/2400 Series Mortice Combination Locks

Combination locks are fully reversible and the function can be changed without removing the case. The auxiliary deadlatch bolt automatically locks the main bolt on closing the door. The combination locks feature is the inside handle is always fixed when locked by the cylinder or snib.



MNC5000

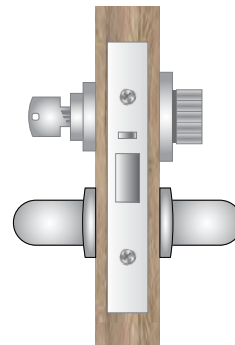
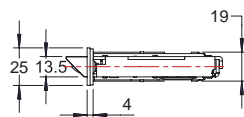
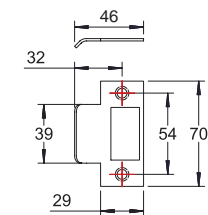
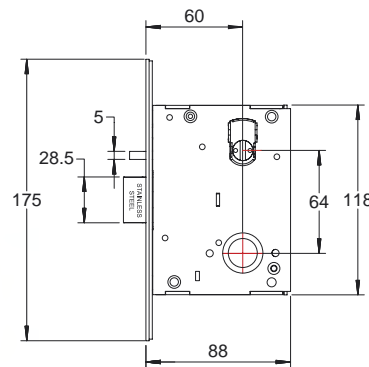

**Combination Entrance Lock
5400 / 2400 / E2400**

Cylinder & Turnsnob

Latchbolt operated by handles from either side. Both handles are locked or unlocked by either key outside or turnsnob inside. Latchbolt automatically deadlatches when door is closed. Available in left and right handing.

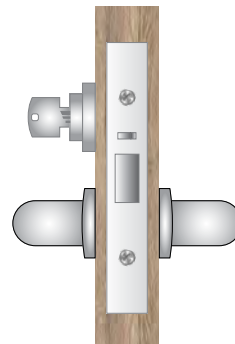

**Entrance Door Lock
5401 / 2401 / E2401**

Single Cylinder

Latchbolt operated by handles from either side. Both handles are locked or unlocked by key from outside. Latchbolt automatically deadlatches when door is closed. Available in left and right handing.

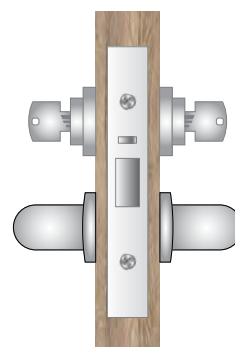

**Glass Door Lock
5402 / 2402 / E2402**

Double Cylinder

Latchbolt operated by handles from either side. Both handles are locked or unlocked by key from outside or key from inside. Latchbolt automatically deadlatches when door is closed. Available in left and right handing.

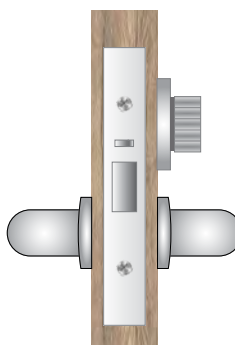

**Patio Door Lock
5403 / 2403 / E2403**

Turnsnob Inside

Latchbolt operated by handle from either side. Both handles are locked or unlocked by turnsnob from the inside. Latchbolt automatically deadlatches when door is closed. Available in left and right handing.



MNC2200



MNC220E



5400/2400 Series Mortise Combination Locks



MNC5000

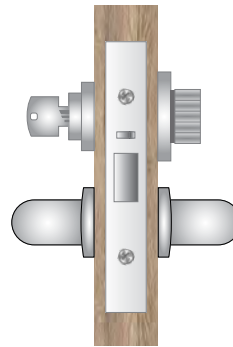
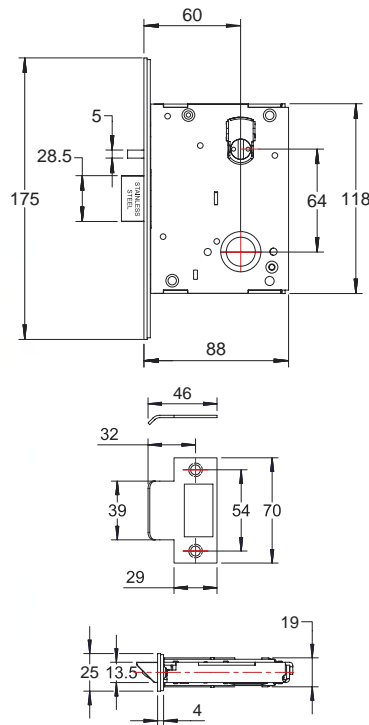

Entrance Office Lock 5405 / 2405 / E2405

Cylinder & Turnsnib

Latchbolt operated by handles from either side. Both handles are locked or unlocked by turnsnib from inside. Key outside retracts latchbolt. Latchbolt automatically deadlatches when door is closed. Available in left and right handing.

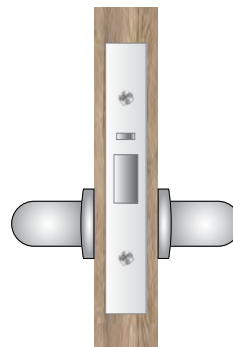

Passage Latch 5409 / 2409 / E2409

Non-locking

Opens by handles either side at all times. Available in left and right handing.

Glass Door Lock 5422 / 2422 / E2422

Double Cylinder

Latchbolt operated by handles from either side. Both handles are locked or unlocked by key from inside. Key outside retracts latchbolt. Latchbolt automatically deadlatches when door is closed. Available in left and right handing.

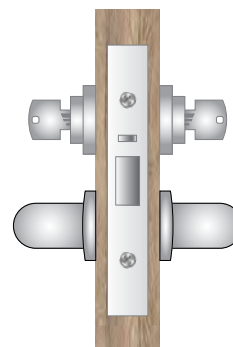

Courtroom Lock 5428 / 2428 / E2428

Double Cylinder

Latchbolt operated by handles from either side. Both handles are locked or unlocked by key from outside or by key from inside. Latchbolt automatically deadlatches when door is closed. Key outside or inside retracts latchbolt. Available in left and right handing.

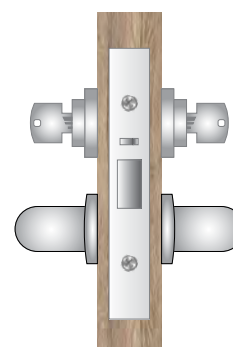

MNC2200



MNC220E

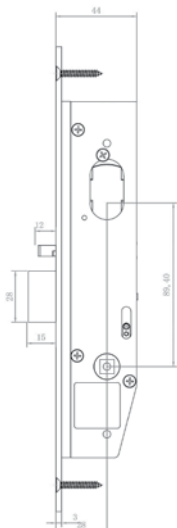

5000 Series Mortice Locks Auxiliary Parts

Rebate Kits – Strike Plates

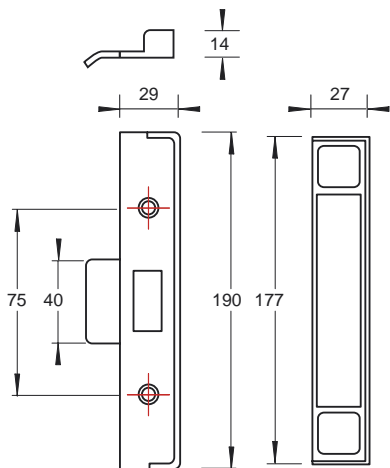

Latch Rebate Kit

SS

MNC5000RK

- For 5000, 5409 & 5000ND

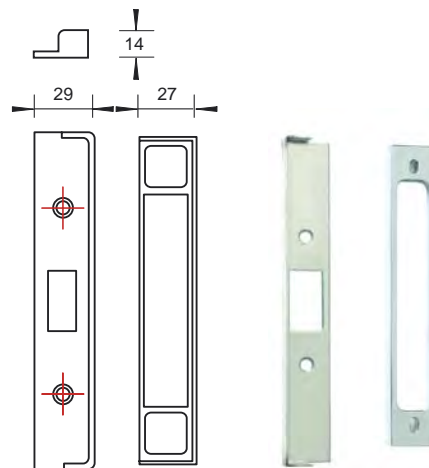

Deadbolt Rebate Kit

SS

MNC5100RK

- For 5100

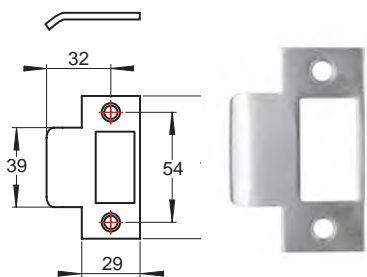

Universal Strike Plate

SS

MNC5000-02

- For 5000 and 2200

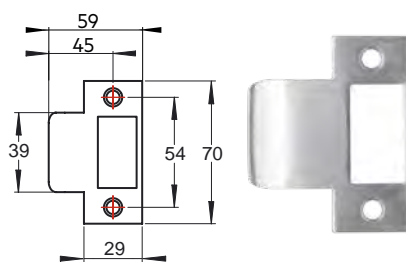

Extended Strike Plate

SS

MNC5000-03

- For 5000 and 2200

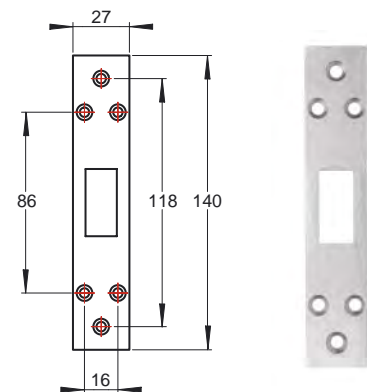

Deadbolt/Sliding Lock Strike

SS

MNC5100-02







- For 5100 and 5300

KEY







- Required
- Select L/H or R/H
- Optional
- * Fit Cam Upside down

5207		5208- pwd		5210		5300		5301		5302		5303		5400		5401		5402		5403		5405		5409		5422		5428			
OUT	IN	OUT	IN	OUT	IN	OUT	IN	OUT	IN	OUT	IN	OUT	IN	OUT	IN	OUT	IN	OUT	IN	OUT	IN	OUT	IN	OUT	IN	OUT	IN	OUT	IN	OUT	IN



CAMS

MNCK2CAM 																														
MNCW2CAM 			● *				●								●															
MNCX2CAM 																														
MNCY2CAM 									●		●	●																		
MNCZ2CAM 																●		●	●											
MNCXZCAM 																														

SNIB Adaptors

MNCAD5000-01LH 																														
MNCAD5000-01RH 																														
MNCAD5100-01 																														
MNCAD5200-01 																														
MNCAD5200-02RH Anti-lockout 																														
MNCAD5200-02LH Anti-lockout 																														

HOLD Back

MNC570HBRH 																														
MNC570HBLH 																														

Other Miles Nelson Products



Kick Plates



Kick Plate 200mm

- 304 grade stainless steel
- 200mmH
- Suitable for commercial applications
- Pre-drilled and countersunk holes
- Stainless steel screws supplied

Door size	Plate Width		
610mm	585mm	500KP610-200	SS
710mm	685mm	500KP710-200	SS
760mm	735mm	500KP760-200	SS
810mm	785mm	500KP810-200	SS
860mm	835mm	500KP860-200	SS
910mm	885mm	500KP910-200	SS



Kick Plate 300mm

- 304 grade stainless steel
- 300mmH
- Suitable for commercial applications
- Pre-drilled and countersunk holes
- Stainless steel screws supplied

Door size	Plate Width		
610mm	585mm	501KP610-300	SS
710mm	685mm	501KP710-300	SS
760mm	735mm	501KP760-300	SS
810mm	785mm	501KP810-300	SS
860mm	835mm	501KP860-300	SS
910mm	885mm	501KP910-300	SS



Push Plate 300mm

- Blank (not engraved) push plate
- Suitable for commercial applications
- 300mmH
- Brushed 304 grade stainless steel
- Fixings supplied

300mm	502PP300-100	SS
-------	--------------	----

Engraved Push Plate 300mm

- Engraved push plate
- Suitable for commercial applications
- 300mmH
- Brushed 304 grade stainless steel
- Fixings supplied

300mm	502PPENGR	SS
-------	-----------	----

Engraved Pull Plate with Handle 300mm

- Engraved pull plate
- Suitable for commercial applications
- 300mmH
- Brushed 304 grade stainless steel
- Fixings supplied

300mm	502PPENGRH	SS
-------	------------	----



Round Sign

- 'Push' sign for restroom doors
- Round 75mm diameter
- Suitable for commercial applications
- Brushed 304 grade stainless steel
- Fixings supplied

Baby Change	503PPTBC	SS
Wheelchair Accessible	503PPTDIS	SS
Men	503PPTM	SS
Men/Women	503PPTM/W	SS
Women	503PPTW	SS
Pull	503PULPR	SS
Push	503PUSPR	SS

Hinges (All components are 304SS for the stainless hinges)

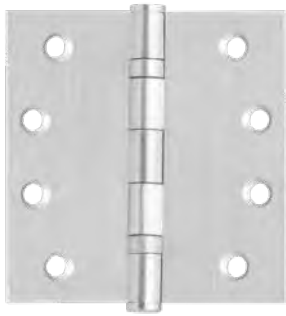

QUALITY STAINLESS STEEL

100 x 100mm

- Fixed pin
- Ball bearing hinge
- Size: 100mmH x 100mmW x 2.5mmD
- 304 grade stainless steel

520SSH100100

SS

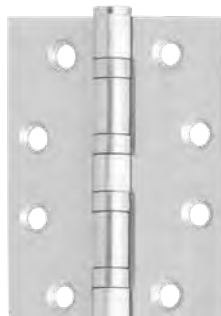

QUALITY STAINLESS STEEL

100 x 75mm

- Fixed pin
- Ball bearing hinge
- Size: 100mmH x 100mmW x 2.5mmD
- 304 grade stainless steel

520SSH10075304S

SS



QUALITY STAINLESS STEEL

100 x 75mm

- Fixed pin
- Ball bearing hinge
- Size: 100mmH x 100mmW x 2.5mmD
- 304 grade stainless steel

520SSH10075R

SS



QUALITY STAINLESS STEEL

100 x 70mm

- Fast fix flush
- Fixed pin
- Sinter bearing hinge
- Size: 100mmH x 70mmW x 2.5mmD
- 304 grade stainless steel

981071FFBSS

SS



110 x 70mm

- Fast fix flush
- Fixed pin
- Size: 110mmH x 70mmW x 4mmD
- Aluminium

520ALU11070H

SA



QUALITY STAINLESS STEEL

90 x 60mm

- Fixed pin
- Size: 90mmH x 60mmW x 2mmD
- 304 grade stainless steel

520SS9060 (square)

SS

520SSH9060R (radius)

SS

Other Miles Nelson Products

Door Accessories



QUALITY STAINLESS STEEL

One Piece Auto Door Holder

- Stainless Steel
- Suitable for doors with door closers: foot operated
- Uses the weight of the door to hold open

807SN

SS



Pedestal Door Holder

- Aluminium satin chrome anodised
- Height 280mm
- Upstand 50mm x 50mm
- Base 90mm x 90mm

Pedestal including 277SC Auto Latch back

618SC

SC

Pedestal including 600SC Manual Latch back

619SC

SC



Heavy Duty Latch Back Wall Mount Door Stop

- Heavy duty suitable for commercial and exterior use
- Forged brass
- Latch Base size 46mmW x 70mmH
- Keeper plate 40mmW x 64mmL
- Self latching

608SCW

SC

B D BRASS LIFETIME GUARANTEE



Mantis Latching Door Stop Floor Mount

- Forged brass
- Latch height 125mmH
Base size 42mmW x 55mmL
- Keeper plate 40mmW x 40mmL
- Self latching with foot release
- Fixings supplied

609SC

SC

609SG

SG

B D BRASS LIFETIME GUARANTEE

DESIGNED BY MILES NELSON



Mantis Latching Door Stop Wall Mount

- Forged brass
- Latch Base size 40mmW x 60mmH
- Keeper plate 40mmW x 40mmL
- Self latching with foot release
- Fixings supplied
- Attached length base to base: 80mm

609SCWM

SC

609SGWM

SG

B D BRASS LIFETIME GUARANTEE

DESIGNED BY MILES NELSON



Heavy Duty Latch Back Floor Mount Door Stop

- Forged brass
- Heavy duty suitable for commercial and exterior use
- Latch height 90mm (145mm for 608SC150)
Base size 46mmW x 70mmL
- Keeper plate 40mmW x 64mmL
- Self latching with foot release

608SC

SC

608PB

MB

608SC150

SC

B D BRASS LIFETIME GUARANTEE

DESIGNED BY MILES NELSON

Door Accessories



Round Base Latching Door Stop Wall Mount

- Fixings supplied
- Swivelling latch

Length 80mm Base size 45mm	600SC	SC
	600PW	PW
	600PB	MB
	600RM	RW



QUALITY STAINLESS STEEL

Stainless Steel Rectangular Wall Mount

- Concealed fixing
- Fixings supplied

Length 70mm Base size 25mm	601SS	SS
Length 100mm Base size 25mm	601SS100	SS



BRASS LIFETIME GUARANTEE

Round Base Rounded Tip Wall Mount

- Forged brass
- Pinned rubber tip
- Fixings supplied

Length 90mm Base size 43mm	204SC	SC
	204SG	SG



Door Stop and Hook

- Fixings supplied

Length 90mm Base size 40mm	702SC	SC
-------------------------------	-------	----



QUALITY STAINLESS STEEL

Door Stop

- Stainless door stop with coat hook pin
- Door must be minimum 20mm thick
- 53mm projection

223SS	SS
-------	----



QUALITY STAINLESS STEEL

Door Stop and Hook

- Concealed fixing
- Fixings supplied
- Centre door fix

Length 95mm Base size 50mm	604SS	SS
-------------------------------	-------	----



Round with Surround Buffer Floor Mount

- Aluminium
- Suits concrete and timber floors

8mm Dynabolt and M8 Hanger Bolt Height 38mm Base size 37mm	207SC	SC
6mm Dynabolt and woodscrew Height 38mm Base size 37mm 2 piece	207SC2	SC
8mm Dynabolt and M8 Hanger Bolt Height 60mm Base size 37mm	207BS60	SC



Contemporary Triangular Base Floor Mount

- Zinc diecast
- Fixings supplied, 3 fixing points

48mm overall height 26mm from base to middle of rubber Base size 62mm x 52mm	98725SC	SC
---------------------------------------------------------------------------------------	---------	----



Hook

- Fixings supplied
- Aluminium

273SC	SC
-------	----

Other Miles Nelson Products

Door Fittings and Flush Bolts



Door Viewer

- 200 degree viewing angle
- Suits door thickness: 35mm-57mm

709SC	SC
709BR	BR



Door Magnet

- Size: 22mm x 6mm
- Countersunk fixings supplied

1 pair	332CP	CP
6 pairs	332/6CP	CP
1 pair magnet with cups	332MWC	CP



Dust Socket

- For use with flush bolts, socket bolts, neck bolts and patio bolts (up to 12mm thick bolt)
- Solid brass
- Length: 47mm
- Flange diameter: 43mm
- Socket diameter: 21mm

314SC	SC
-------	----



Flush Necked Bolt

- Solid brass
- Available in standard non-locking or key locking function
- Length 150mm Bolt 9mm Throw 30mm
- Keyed alike available on request
- Supplied with 2 keys
- For extra key blanks refer page 40

Non-locking	405SC150	SC
	405SG150	SG
Locking	405SCL150	SC
	405SGL150	SG

B D BRASS LIFETIME GUARANTEE
DESIGNED BY MILES NELSON

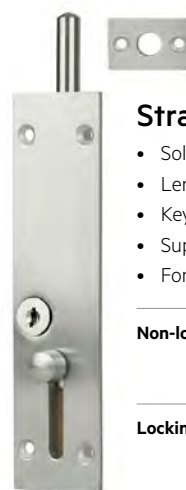

Straight Flush Bolt

- Solid brass
- Length 150mm Bolt 9mm Throw 30mm
- Keyed alike available on request
- Supplied with 2 keys
- For extra key blanks refer page 40

Non-locking	505SC150	SC
	505SG150	SG
Locking	505SCL150	SC
	505SGL150	SG

B D BRASS LIFETIME GUARANTEE
DESIGNED BY MILES NELSON



Flush Lever Bolt

- Forged solid brass
- Size 150mm x 25mm, Throw 18mm Rod 12mm
- Fixings supplied
- Brushed satin chrome finish

305SC150	SC
----------	----

B D BRASS LIFETIME GUARANTEE

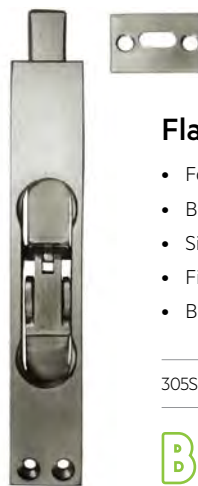

Flat Bar Flush Lever Bolt

- Forged solid brass
- Bolt is a flat bar
- Size 150mm x 25mm Throw 18mm
- Fixings supplied
- Brushed satin chrome finish

305SC150F	SC
-----------	----

B D BRASS LIFETIME GUARANTEE

Socket Bolts, Necked Bolts and Cabin Hooks



Socket Bolts

- Made from seamless brass with an 8mm or 10mm rod
- Fixings supplied



35mm	262BR0835BP	BR
	262CP0835BP	CP
	262FB0835BP	FB
	262SC0835BP	SC
50mm	262BR0850BP	BR
	262CP0850BP	CP
	262FB0850BP	FB
	262SC0850BP	SC
60mm	262BR0860BP	BR
	262CP0860BP	CP
	262FB0860BP	FB
	262SC0860BP	SC
75mm	262BR0875BP	BR
	262CP0875BP	CP
	262FB0875BP	FB
	262SC0875BP	SC
100mm	262BR08100BP	BR
	262CP08100BP	CP
	262FB08100BP	FB
	262SC08100BP	SC
	262SG08100BP	SG
	262SS100BP	SS
150mm	262BR10150	BR
	262CP10150	CP
	262FB10150	FB
	262SC10150	SC
	262SG10150	SG
	262SS10150	SS
200mm	262BR10200	BR
	262CP10200	CP
	262FB10200	FB
	262SC10200	SC

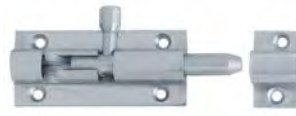

Necked Bolts

- Made from seamless brass with an 8mm or 10mm rod
- Fixings supplied



60mm	269BR0860BP	BR
	269CP0860BP	CP
	269FB0860BP	FB
	269SC0860BP	SC
75mm	269BR0875BP	BR
	269CP0875BP	CP
	269FB0875BP	FB
	269SC0875BP	SC
100mm	269BR08100BP	BR
	269CP08100BP	CP
	269FB08100BP	FB
	269SC08100BP	SC
	269SN08100	SN
	269SG08100	SG
150mm	269BR10150	BR
	269CP10150	CP
	269FB10150	FB
	269SC10150	SC
	269SN10150	SN
	269SG10150	SG



Cabin Hooks - Commercial

- Super heavy duty

150mm	376SS150	SS
200mm	376SS200	SS



Cabin Hooks

- Made from forged brass with an 8mm or 10mm rod
- Fixings supplied



50mm	276BR0850BP	BR
	276CP0850BP	CP
	276FB0850BP	FB
	276SC0850BP	SC
75mm	276BR0875BP	BR
	276CP0875BP	CP
	276FB0875BP	FB
	276SC0875BP	SC
100mm	276SG0875BP	SG
	276BR08100BP	BR
	276CP08100BP	CP
	276FB08100BP	FB
	276SC08100BP	SC
	276SN08100	SN
150mm	276SG08100BP	SG
	276SS100BP	SS
	276BR10150	BR
	276CP10150	CP
	276FB10150	FB
	276SC10150	SC
200mm	276SS150BP	SS
	276BR10200	BR
	276CP10200	CP
	276FB10200	FB
	276SC10200	SC

Other Miles Nelson Products

Bannister Brackets

Lumos® Bannister Bracket

The revolutionary Lumos® LED bannister bracket seamlessly blends function and design by providing lighting within a bannister or railing bracket body.

This development simplifies the installation of safety or railing illumination into one stylish bracket.

The brackets use low energy consumption LED bulbs with a life of approximately 12 years under continuous use. The light does not produce heat and is therefore safe to touch. Recommended bracket spacing is 900mm, as light coverage area at maximum height is 900mm. One transformer can power up to 16 brackets containing LEDs.

Requires the use of a Miles Nelson regulated power transformer, supplied separately. Complies with BIA acceptable solution D1/AS1. Can also be used with photosensitive sensors for night lighting.

Lumos brackets are designed and manufactured in New Zealand.



DESIGNED BY
MILES NELSON

- Lumos® bannister bracket
- 12 volt LED downlight
- Very low power consumption
- Cool running
- Adapter for flat profile rails
- Fixings supplied
- Base: 52mm x 50mm
- Wall projection: 70mm
- Upstand height: 80mm
- Overall height: 115mm

Indoor use	610SCBP	SC
Powder coated finish for outdoor use	610SCEBP	SC
Indoor use (without light)	611SCBP	SC
	611CP	CP
Powder coated finish for outdoor use (without light)	611SCBP	SC



Lumos® Transformer

- 12 volt
- Each transformer can power 16 lights
- Tested to AS/NZS3108 at 25°C

612PA

DESIGNED BY
MILES NELSON



- Concealed fixing
- Suits square and round rails
- Includes flat rail adapter
- Fixings supplied
- Base diameter: 58mm
- Wall projection: 75mm
- Upstand height: 75mm
- Complies with BIA acceptable solution D1/S1

310SC	SC
310SG	SG
310PB	MB
310SN	SN

DESIGNED BY
MILES NELSON



- Concealed fixing
- Fixings supplied
- Includes flat rail adapter
- Base: 55mm
- Wall projection: 78mm
- Upstand height: 60mm
- Tested to 400kg load
- SGS test certificate INZ70574-01

810SCWB1	SC
810SGWB	SG
810PBWB	MB
810SNWB1	SN

DESIGNED BY
MILES NELSON



- Concealed fixing
- Fixings supplied
- Includes flat rail adapter
- Supplied with hanger bolt
- Base: 30mm
- Wall projection: 70mm
- Upstand height: 60mm

810SC1	SC
810SG	SG
810PB	MB
810SN1	SN

Bannister Brackets

316 MARINE GRADE STAINLESS STEEL

DESIGNED BY MILES NELSON



Glass fixing bracket*

- Polished 316 marine-grade stainless steel
- Suitable for exterior use
- Concealed fixing
- Fixings supplied
- Removable saddle
- Base diameter: 55mm
- Wall projection: 78mm
- Upstand height: 75mm
- Tested to 800kg load
- SGS test certificate INZ70574-01

Bannister Bracket	810SSWB1	SS
Glass fixing kit	810SSGFK	SS
Flat Plate Adaptor	810SSA	SS

*8mm through fixing (14mm minimum hole size)

316 MARINE GRADE STAINLESS STEEL



- 316 grade stainless steel
- Concealed fixing
- Fixings supplied
- Suits commercial applications
- Base: 65mm
- Wall projection: 78mm
- Upstand height: 75.5mm

Bannister Bracket with Saddle	621SS	SS
Bannister Bracket without Saddle	620SS	SS

S QUALITY STAINLESS STEEL



- 304 solid stainless steel
- Fixings supplied
- Flat handrail adaptor available
- Base diameter: 54.8mm
- Wall projection: 74mm
- Upstand height: 51mm

Bannister Bracket	813SS	SS
Flat Plate Adaptor	813SSA	SS

Bathroom Indicator Hardware



Indicator Bolt

- Zinc on alloy
- Suit doors 28-45mm thick
- Surface mounted

3065SC SC



Indicator Bolt

- Stainless steel 304
- Suit doors 28-45mm thick
- Surface mounted

710SS SS

S QUALITY STAINLESS STEEL



Indicator Hook

- Stainless indicator hook
- Suits 28-50mm thick
- Surface mounted with 6 fixing points
- 6mm square spindle
- Suit sliding and hinged doors
- Includes 10mm packer
- Two strike options

790SS SS

S QUALITY STAINLESS STEEL

Other Miles Nelson Products

Safety and Security



Patio Bolt

- Secure locking function
- Concealed screws for extra security
- Quality construction, 10mm bolt
- Unique slimline design, 22mm body width
- Suitable for new weather sealed joinery
- DIY friendly installation
- Recommended for interior use only

1 piece pack	281PW1	
	281SC1	
	281PB1	
2 piece pack (key alike)	281PW2	
	281SC2	
	281PB2	



Mini Bolt

- Secure locking function
- Concealed screws for extra security
- Quality construction
- Suitable for new weather sealed joinery
- DIY friendly installation
- Recommended for interior use only

1 piece pack	282PW1	
	282SC1	
	282PB1	
2 piece pack (key alike)	282PW2	
	282SC2	
	282PB2	



Miles Nelson Key Blank

- Suits 281/282/405/505

28 KEY



QUALITY STAINLESS STEEL

Window Opening Restrictor

- Suitable for aluminium windows
- Quality stainless steel construction
- Positive stop position

1 pair Includes packers and screws	251REST2PK	
2 pairs Includes packers and screws	251REST4PK	
20 pairs Trade box	251RESTB	
100 pairs Trade box	251RESTB100	

SUITABLE FOR L & R HAND APPLICATION



Window Opening Restrictor for Aluminium Windows

- Restricts window opening
- Three locating positions
- Unique glide design for ease of use
- Window can be fully opened when disengaged if required
- Powder coat finish

1 piece pack	250SCA1	
	250PWA1	
	250PBA1	
2 piece pack	250PWA2	
	250PBA2	
4 piece pack	250SCA4	
	250PWA4	
	250PBA4	

SUITABLE FOR L & R HAND APPLICATION



Window Opening Restrictor for Timber Windows

- Restricts window opening
- Three locating positions
- Unique glide design for ease of use
- Window can be fully opened when disengaged if required
- Powder coat finish

1 piece pack	250PWT1	
	250SCT1	
2 piece pack	250PWT2	
4 piece pack	250PWT4	
	250SCT4	

SUITABLE FOR L & R HAND APPLICATION

Door Accessories



Euro Mortice Lock

- Stainless steel faceplate
- 85mm centre spindle to centre keyway

60mm Backset	716SS60	SS
45mm Backset	716SS45	SS
Rebate Kit	720SS	SS



5 Lever Mortice Lock

- 58mm Backset
- Case depth 80mm/ Case height 109mm

Mortice Lock with 2 keys	716SN765	SN
5 Lever Key Blank	716KB5	
Rebate Kit for 716SN765	716SN12	SN



3 Lever Mortice Lock

- 2 keys supplied
- 54mm centre spindle to top of keyway

48mm Backset	716SSN663	SN
Case depth 64mm/ Case height 103mm		
58mm Backset	716SSN763	SN
Case depth 77mm/ Case height 103mm		



70mm Euro Cylinder

- 6 pin
- C4 profile keyway
- Keyed alike option
- 3 keys supplied

Double cylinder	718SG70KD	SG
Cylinder and turn	717BLK70KD	MB
Cylinder and turn	717SN70KD	SN
Cylinder and turn	717SG70KD	SG



Rebate kit (12.5mm)

- For standard tubular latch (24.5mm hole)

291BR / 291CP / 291FB / 291SC



3 Lever Key Blanks

Use with 716SSN763 & 716SSN663

716KKB3L	SN
----------	----

Use with 716SSN763 & 716SSN663

716KKB3R	SN
----------	----



Privacy Turn Set

- Satin Nickel finish
- 5mm spindle
- Projection 10mm
- Rose diameter 55mm
- Use with MIL320

Round Rose	MIL300	SN
Square Rose	MIL305	SN



Tubular Privacy Bolt

- Satin Nickel finish
- 5mm square spindle
- 60mm backset
- Use with MIL300

MIL320

SN



Tubular Latch

- Satin Nickel finish
- 8mm spindle
- Recessed box shield included

60mm backset

MIL325	SN
--------	----

70mm backset

415SN70	SN
---------	----

Milano Range Lever Handles

Door Handle Sets

Lever Set	levers only (no latchset)
Passage Set	includes lever set and 60mm tubular latch
Dummy Set	includes dummy lever and taylor spindle
Entrance Set	includes lever set, euro escutcheons, 716SS60 euro mortice lock and euro cylinder and turn
Long Plate set	levers only - order 716SS60 euro mortice lock and euro cylinder separately
Integrated Privacy Set	includes privacy lever set and 60mm privacy tubular latch

Order Codes

Lever Set (furniture only) See next page

Passage Set	_____1
Dummy Set	_____3 (LH + RH for TIV and ANZ)
Entrance Set	_____4
Longplate (furniture only)	_____6
Integrated Privacy	_____8

Add SG or BLK at end of part code for black or satin graphite.
eg. PAR101BLK= Parma Round Passage Set Black

Milano Longplate Handles

- Satin nickel finish only
- Plate length W 33mm x L 240mm
- All Milano lever handles available in square round edge plates

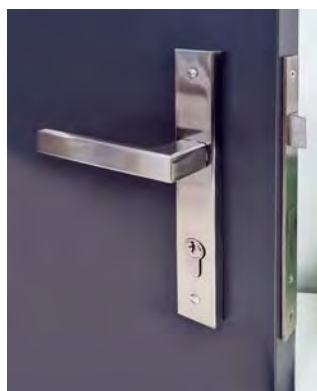

Milano Entrance Set

- All Milano lever styles available as an entrance set
- Available in round or square rosette
- Key and turn cylinder



Milano on fire rated lock



- With a special fixing kit, all Milano styles on next page are compatible with the MNC5000 fire rated mortice lock.
- Choose lever style – VER200 shown
- Use special lever handle fixing kit – MNCMIL2
- Fire rated mortice – MNC5000
- Also pictured – MIL406 escutcheon and MNC570 oval cylinder
- Special fixing kit also available to fit Milano privacy turns to MNC5000



Special Fixing Kits

- Use MNCMIL1 to adapt privacy turn sets MIL300 and MIL305 to MNC5000 mortice lock
- Use MNCMIL2 to adapt Milano lever sets to MNC5000 mortice lock

For Privacy Set MNCMIL1

For Lever Set MNCMIL2

Oval Escutcheons

- Satin Nickel finish
- 55mm
- Matches Milano lever handles

Round Base MIL401

Square Base MIL406

- High quality zinc alloy lever handles designed for comfort
- Available with round or square 55mm rosette
- Easy installation – 25mm hole
- Locking handle grub screw, ensures a firm handle action
- Solid mechanical components for superior and long lasting performance

10 YEAR MECHANICAL WARRANTY

Square Rosette



Lucca - Square Rosette Passage Set

LUC201 **SN**



Verona - Square Rosette Passage Set

VER201 **SN**

VER201SG **SG**

VER201BLK **MB**



Parma - Square Rosette Passage Set

PAR201 **SN**



Forli - Square Rosette Passage Set

FOR201 **SN**

Round Rosette



Lucca - Round Rosette Passage Set

LUC101 **SN**



Verona - Round Rosette Passage Set

VER101 **SN**

VER101BLK **MB**



Parma - Round Rosette Passage Set

PAR101 **SN** PAR101BLK **MB**

PAR101SG **SG** PAR101MBC **BC**



Tivoli - Round Rosette Passage Set

TIV101 **SN** *Note – Dummies are handed. Left hand shown.*

TIV101SG **SG**

TIV101MBC **BC**



Anzio - Round Rosette Passage Set

ANZ101 **SN** *Note – Dummies are handed. Left hand shown.*



Integrated Privacy

- All styles available for Integrated Privacy
- Forli Round Rosette Lever set shown. FOR108



Privacy Turn Set / Privacy Bolt

- See page 41 for more information.

Other Miles Nelson Products

Pull Handles (All handles include nylon buffers and 12mm bushes for glass mount)



M1

- 316 grade stainless steel tube
- Back to back pair
- Fixings supplied
- Suits door thickness: 40mm-52mm

Size: 300mm C/C: 260mm	781SS300	SS
Size: 450mm C/C: 410mm	781SS450	SS
Size: 600mm C/C: 560mm	781SS600	SS
900mm C/C: 860mm	781SS900	SS
1200mm C/C: 1160mm	781SS1200	SS

316 MARINE GRADE STAINLESS STEEL



M1

- 316 grade stainless steel tube
- Back to back pair
- Fixings supplied
- Suits door thickness: 40mm-52mm
- Electroplated

600mm C/C: 560mm	781SS600BLK	
---------------------	-------------	--

316 MARINE GRADE STAINLESS STEEL



M1

- 316 grade stainless steel tube
- Back to back pair
- Fixings supplied
- Suits door thickness: 40mm-52mm
- Electroplated

600mm C/C: 560mm	781SG600	SG
---------------------	----------	----

316 MARINE GRADE STAINLESS STEEL



M2

- 316 grade stainless steel tube
- Back to back pair
- Fixings supplied
- Suits door thickness: 40mm-52mm

Size: 300mm C/C: 250mm	782SS300	SS
Size: 450mm C/C: 400mm	782SS450	SS
Size: 600mm C/C: 550mm	782SS600	SS
900mm C/C: 850mm	782SS900	SS

316 MARINE GRADE STAINLESS STEEL



M3 Offset

- 316 grade stainless steel tube
- Back to back pair
- Fixings supplied
- Suits door thickness: 40mm-52mm

Size: 600mm C/C: 575mm	783SS600	SS
---------------------------	----------	----

316 MARINE GRADE STAINLESS STEEL



M3 Torch

- 316 grade stainless steel tube
- Back to back pair
- Fixings supplied
- Suits door thickness: 40mm-52mm

Size: 530mm C/C: 250mm	784SS	SS
---------------------------	-------	----

316 MARINE GRADE STAINLESS STEEL



M3 Round

- 316 grade stainless steel tube
- Back to back pair
- Fixings supplied
- Suits door thickness: 40mm-52mm

Size: 450mm C/C: 300mm	785SS450	SS
600mm C/C: 450mm	785SS600	SS

316 MARINE GRADE STAINLESS STEEL



M3 Square

- 316 grade stainless steel tube
- Back to back pair
- Fixings supplied
- Suits door thickness: 40mm-52mm

Size: 450mm C/C: 300mm	786SS450	SS
600mm C/C: 450mm	786SS600	SS

316 MARINE GRADE STAINLESS STEEL



General Purpose Handle

Size: 114mm	088SC114	SC
Size: 150mm	088SC150	SC



Latch Turn Kits

- Double turns and tubular latch
- Can work with pull handle and deadbolt to latch door shut
- 60mm backset

Square	719SSN	SN
	719SSG	SG
	719BLK	MB
Round	719RSN	SN
	719RSG	SG
	719RBLK	MB



Pull handle lock kit

- 11mm protruding escutcheons / suits up to 49mm thick door when used with 70mm euro cylinder
- Provides a secure latch with turns both sides for doors with pulls
- Corrosion resistant stainless faceplate
- Order euro cylinder separately refer page 41
- 60mm back set / 85mm centre to centre

Square	716SNSLK60	SN
	716SGSLK60	SG
	716BLKSLK60	MB
Round	716SNRLK60	SN
	716SGRLK60	SG
	716BLKRLK60	MB

*Note: Face and striker plates only supplied as stainless steel

Warranty Information

5 YEAR MILES NELSON WARRANTY

Products covered: All General Hardware Products including Bannister Brackets, Bathroom Fittings, Cabinet Hardware & Handles, Cabin Hooks, Door Fittings, Door Stops, Hinges, Hooks, Kickplates, Push Plates, Grab Rails, Letterbox Letters & Numbers, Neck Bolts, Security Fittings (excluding the Patio Bolts, Mini Bolts, Restrictor Stays and Security Window Stays) and Socket Bolts.

These products are warranted to be free from mechanical and workmanship defects for 5 years from the original date of purchase. If a mechanical defect occurs simply return the product together with proof of purchase to point of purchase for replacement.

Over time the surface may deteriorate if exposed to adverse atmospheric conditions caused by sea, air and weather. Finish deterioration caused by exposure to adverse atmospheric conditions or occurring from the use of paints, solvents, acid cleaners or scratching from keys is not considered a defect in the finish and is not covered by the warranty conditions.

Likewise the warranty does not cover damage caused by incorrect installation, accident, neglect or other factors over which Miles Nelson have no control and as such Miles Nelson shall not be held liable for any losses or expenses such as loss of use, damage to property or consequential damages or expenses.

10 YEAR MILES NELSON WARRANTY

Products covered: Miles Nelson Commercial Door Furniture, Miles Nelson Commercial Door Closers, Door Handles & Pulls, Restrictor Stays, Security Window Stays, Patio Bolts and Mini Bolts.

These products are warranted to be free from workmanship defects for 10 years from the original date of purchase. If a defect is detected simply return the product together with proof of purchase to the supplier for replacement. Products are designed for interior residential applications, unless otherwise stated.

Over time the surface may deteriorate if exposed to adverse atmospheric conditions caused by sea, air and weather. Finish deterioration caused by exposure to adverse atmospheric conditions or occurring from the use of ammoniated detergents, metal polishes, solvents, corrosive environments or other abrasive agents or scratching from keys is not considered a defect in the finish and as such is not covered by the warranty.

Likewise, the warranty does not cover damage caused by incorrect installation, accident, neglect or other factors over which Miles Nelson have no control and as such Miles Nelson shall not be held liable for any losses or expenses such as loss of use, damage to property or consequential damages or expenses.

25 YEAR MILES NELSON WARRANTY

Miles Nelson Manufacturing Ltd guarantees its products against defects in workmanship and materials. Should the product develop fault within its normal working life, Miles Nelson will repair or replace product of the same or equivalent product free of charge. Miles Nelson Manufacturing Ltd assumes no liability under this guarantee for the following.

1. Incorrect installation or failure to follow instructions.
2. Failure through improper maintenance or fair wear and tear.
3. Loss or damage costs incurred either indirect or consequential.
4. Cost of removal, replacement, and/or travelling time.
5. Any modification to the product from its original supplied operation design.
6. Plated finishes deterioration under some climatic conditions or chemical environment are exempt from this guarantee.

Miles Nelson Manufacturing Ltd reserves the right to determine whether or not any fault is caused by defects in workmanship or that any product is defective. Product specification and design improvement may change as a result of our continued commitment to quality, materials and development program. Consumer Guarantees act does not apply.

Warranty Information and Finishes

B BRASS LIFETIME GUARANTEE

The lifetime warranty covers the integrity of the product(s) base material and as such the product is guaranteed to be free from material defects for the lifetime of the product.

The product finish is subject to the same conditions that apply to the 5 year warranty, as above.

316 MARINE GRADE
STAINLESS STEEL

S QUALITY
STAINLESS
STEEL

There are two types of stainless steel commonly used in the hardware industry, 304 grade and 316 (marine) grade. 316 grade stainless has molybdenum as an additive that improves its resistance to pitting and corrosion and should be used when exposed to seaside conditions.

With a little bit of care you can minimise, if not prevent tea staining and get years of visual enjoyment from your stainless steel.

Tea staining can be described as: discolouration of the surface of stainless steel that does not affect the structural integrity or the longevity of the material. Tea staining of stainless steels occurs most commonly in coastal areas and becomes progressively worse the closer you get to water (note that most of New Zealand is considered a coastal area). Other factors such as pollution, higher temperatures and humidity can also increase the effect.

To prevent tea staining, perform regular maintenance – Wash regularly with clean fresh water, mild detergent and a cloth or soft brush. After washing rinse in clean water and wipe the surface dry with a soft absorbent cloth remembering to go with the grain on brushed stainless steel. Generally, you should wash your stainless steel every time you wash your windows or every three months. Do not use abrasive cleaners or a scouring pad of any type as they may cause excessive wear and dull the finish.

Finishes and Terminology

SS Stainless Steel

MB Matt Black

BR Brass

CP Chrome Plate

SN Satin Nickel

SG Satin Graphite

FB Florentine Bronze

SA Satin Anodised

SC Satin Chrome

PW Powder Coat White



290
280
270
260
250
240
230
220
210
200
190
180
170
160
150
140
130
120
110
100
90
80
70
60
50
40
30
20
10

Miles Nelson[®]

MNC

Commercial

For Orders:

P: 0800 663 5766

F: +64 9 489 5552

E: orders@milesnelson.co.nz

**Overnight courier service
available on request.**

For Technical Enquiries:

P: 0800 663 533

E: commercial@milesnelson.co.nz

PO Box: 31 043, Milford, Auckland



To view the full range of products visit:

 **[milesnelson.co.nz](https://www.milesnelson.co.nz)**

Follow us on:

 **[milesnelsonNZ](https://www.facebook.com/milesnelsonNZ)**

 **[MilesNelsonNZ](https://www.pinterest.com/MilesNelsonNZ)**

 **[milesnelsonnz](https://www.instagram.com/milesnelsonnz)**